



ENA 5 (EA/SA/INTA)

Instructions for Use



Additional online content

Tap, click or scan the QR code to access additional online resources.

There are video tutorials to help you operate your ENA 5.





jura.com/support-ENA5

Your ENA

1 Control elements	3
2 For your safety	4
Comply with the instructions for use	4
Proper use	4
User limitations	4
Use by children	4
What to do in the event of damage	4
Preventing damage	5
Danger of electric shock	5
Danger of burns, scalding and injury	5
3 Preparing and using for the first time	6
Setting up the machine	6
Filling the bean container	6
Determining the water hardness	6
First-time use	6
Managing your ENA – the JURA Cockpit	7
4 Preparation	8
The indulgence worlds of your ENA 5	8
Basic preparation procedure	8
Espresso and coffee	8
Cold Brew	8
Ground coffee	9
Adjusting the grinder	9
Adjusting the product settings	10
5 Daily operation	10
Switching the machine on and off	10
Filling the water tank	10
Maintenance actions	11
6 Machine settings	11
7 Maintenance	11
Rinsing the machine	12
Inserting/changing the filter	12
Cleaning the machine	13
Descaling the machine	14
Descaling the water tank	15
Cleaning the bean container	15
8 Display messages	16
9 Troubleshooting	16
10 Transport and environmentally friendly disposal	17
Transport / Emptying the system	17
Disposal	17
11 Technical data	17
12 Index	18
13 JURA contact details / Legal information	19

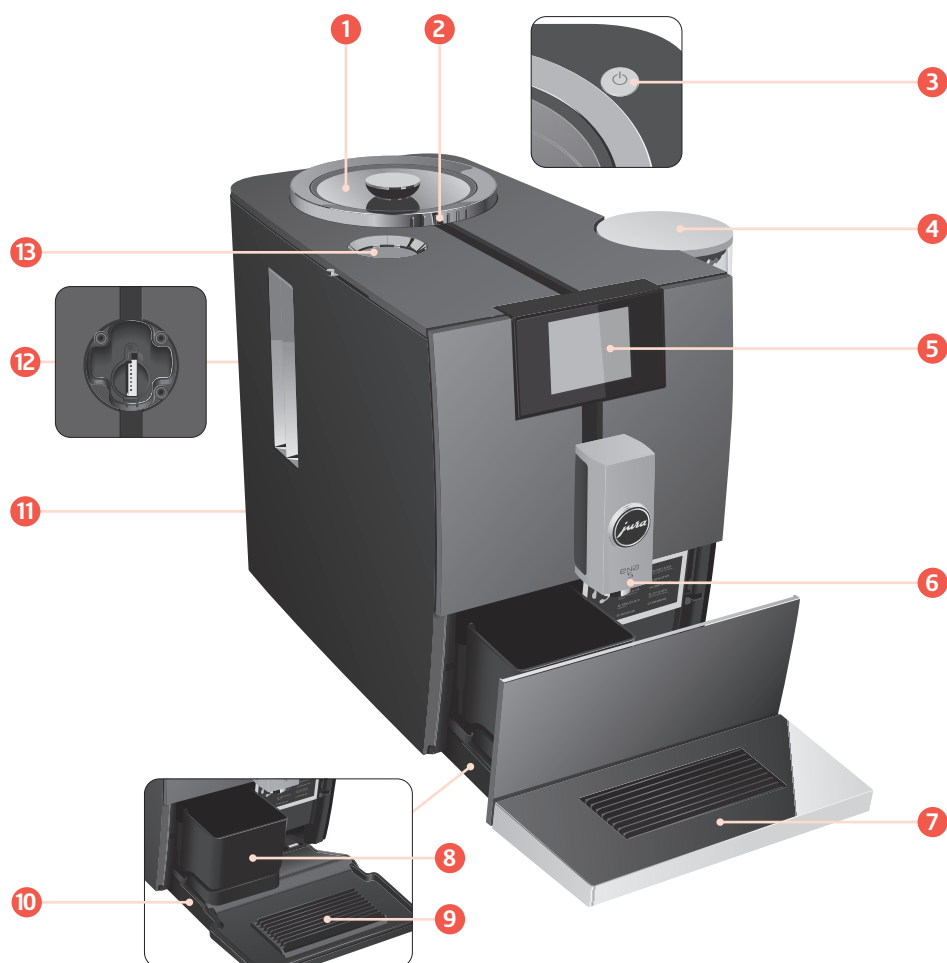
1 Control elements



- 1 Bean container with aroma preservation cover
- 2 Grinding wheel
- 3 On/Off button 
- 4 Water tank (with cover)
- 5 Touch display
- 6 Height-adjustable coffee spout
- 7 Cup grille with aperture
- 8 Coffee grounds container
- 9 Insert for drip tray
- 10 Drip tray
- 11 Mains cable (back of the machine)
- 12 Service socket for optional JURA Wi-Fi Connect
- 13 Powder chute for ground coffee
- 14 Filler funnel for ground coffee
- 15 Measuring spoon for ground coffee

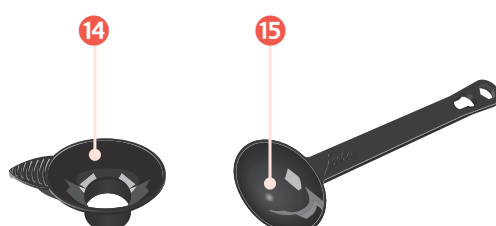



2 For your safety

Comply with the instructions for use

Before using the machine, read these instructions for use thoroughly and completely and comply with the instructions they contain. Keep these instructions for use close to the machine and pass them on to the next user.

Failure to observe the instructions for use may result in serious injuries or damage to property. Safety information is therefore indicated as follows:

 WARNING	Indicates circumstances that may result in serious injuries or death.
 CAUTION	Indicates circumstances that may result in minor injuries.
CAUTION	Indicates circumstances that may result in damage to property.

Proper use

The machine is intended for private domestic use. It is designed solely for the preparation of coffee. Use for any other purpose will be deemed improper.

User limitations

People, including children, who

- do not have the physical, sensory or mental capabilities to use the machine safely or
- are inexperienced or lack knowledge

must be supervised by a responsible person when using it, or must be instructed in how to use it correctly.

When using the CLARIS Smart+ filter cartridge or a JURA Wi-Fi Connect, wireless connections are established. Specific details on the frequency band used and the maximum transmission power can be found in the '11 Technical data' section.

Use by children

Children must be able to recognise and understand the potential dangers arising from incorrect use:

- Keep **children under the age of 8** away from the machine, or supervise them constantly.
- **Children aged 8 and over** may only operate the machine without supervision if they have been instructed in how to use it safely.
- Children may not clean or service the machine unless supervised by a responsible person.
- Do not allow children to play with the machine.

What to do in the event of damage

Never use a damaged machine or mains cable. This could result in fatal electric shock.

- In the event of signs of damage, disconnect the machine from the mains. To do this, first switch the ENA off with the On/Off button . Only then should you remove the mains plug from the power socket.
- Only permit authorised JURA service centres to carry out **repairs to the machine** and the **permanently connected mains cable**. Unsuitable repairs may result in consequential damage.

Preventing damage

To avoid damage to the machine and the mains cable:

- The ENA must not be placed in a cabinet when in use.
- Do not use the ENA and the mains cable near hot surfaces.
- Do not allow the mains cable to rub against sharp edges and ensure that it does not become trapped.
- Never allow the mains cable to loosely hang down. The mains cable could pose a tripping hazard or become damaged.
- Protect the ENA from weather and direct sunlight.
- Only connect the ENA to a mains voltage corresponding to that stated on the rating plate. The rating plate is located on the underside.
- Connect the ENA directly to a domestic power socket. Using multi-socket adapters or extension cords may cause overheating.
- The surface of the heating element and outer enclosure remains hot after use and the outside of the appliance may retain heat.
- Do not use alkaline or alcohol-based cleaning agents; only use mild cleaning agents and a soft cloth.
- Do not use any coffee beans treated with additives or caramelised coffee beans.
- Only fill the water tank with fresh, cold, non-carbonated water.
- Switch the machine off with the On/Off button  if you are going to be absent for a longer period of time and remove the mains plug from the power socket.
- Only use original JURA maintenance products. Use of products that are not explicitly recommended by JURA could damage your ENA.

Danger of electric shock

Water conducts electricity. Do not bring water and electricity into contact with one another:

- Never touch the mains plug with wet hands.
- Do not immerse the ENA and/or mains cable in water.
- Do not put the ENA or any individual parts in the dishwasher.
- Before cleaning, switch the ENA off with the On/Off button . Always wipe the ENA with a damp cloth rather than a wet one, and protect it from prolonged exposure to water splash. The ENA must not be cleaned with a jet of water.
- The ENA is not suitable for installation on a surface where a jet of water can be used.

Danger of burns, scalding and injury

- Do not touch the spouts during operation. Use the handles provided.
- Optionally, your ENA can be remotely operated using mobile devices. When preparing a product or initiating a maintenance programme, make sure that other people are not put at risk – for example, through contact with the spouts.

3 Preparing and using for the first time

Setting up the machine

- ▶ Choose a spot for your ENA which protects the machine against overheating. Ensure that the ventilation slots are not covered.

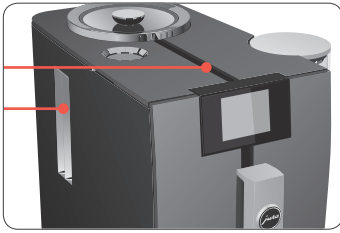

- ▶ Place the ENA on a horizontal surface that is not sensitive to water.

Filling the bean container

The aroma preservation cover on the bean container ensures that the aroma of the beans is retained for longer.

CAUTION

Coffee beans which have been treated with additives (e.g. sugar), ground coffee or freeze-dried coffee will damage the grinder.

- ▶ Only use roasted, untreated coffee beans to fill the bean container.

- ▶ Remove the aroma preservation cover.
- ▶ Fill the bean container with coffee beans and close the aroma preservation cover.

Determining the water hardness

When you use the machine for the first time, you must set the water hardness. If you know the hardness of your water, go straight to the next section. If you do not know the water hardness, you can find this out first:

- ▶ Hold the Aquadur® test strip supplied under running water for one second. Shake off the water.
- ▶ Wait for about 1 minute.
- ▶ You will then be able to read the degree of water hardness from the discolouration of the Aquadur® test strip and the description on the packaging.

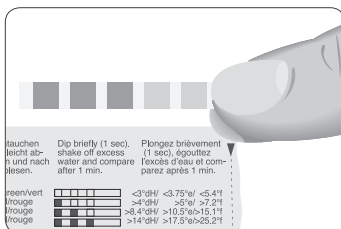

First-time use

⚠ WARNING

If the machine is operated with a defective mains cable, there is a danger of potentially fatal electric shock.

- ▶ Never use a machine which is damaged or has a defective mains cable.

CAUTION

Milk, sparkling mineral water or other liquids can damage the water tank or the machine.

- ▶ Only fill the water tank with fresh, cold water.

Precondition: The bean container has been filled.

- ▶ Insert the mains plug into a power socket.
- ▶ Press the On/Off button  to switch the ENA on.

‘Sprachauswahl’ / ‘Deutsch’

- ▶ To display more languages, tap < or > until the preferred language is shown (e.g. ‘English’).

- ▶ Touch ‘Save’.

‘Saved’ appears briefly on the display.

‘Water hardness’

- i** If you do not know the hardness of your water, you must find this out first (see chapter 3 'Preparing and using for the first time – Determining the water hardness').
- Touch < or > to change the water hardness setting.
- Touch 'Save'.
'Saved' appears briefly on the display.
- Touch 'Insert filter'.
- Place a receptacle under the coffee spout.



- Remove the water tank and rinse it with cold water.
- Fit the filter cartridge extension supplied on top of the CLARIS Smart+ filter cartridge.

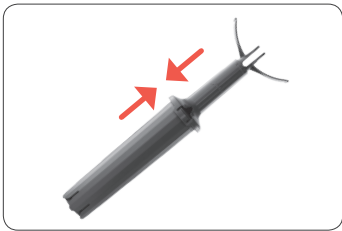

- Insert the filter cartridge with its extension into the water tank.

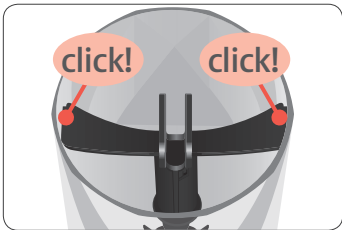

- Fill the water tank with fresh, cold water and reinsert the tank.

- i** The machine automatically detects that you have just inserted the filter cartridge.

'Saved'

'Filter is being rinsed', the filter is rinsed. Water flows directly into the drip tray.

'Machine is heating'



'Machine is rinsing'

The rinse stops automatically. The start screen is displayed. Your ENA is ready for use.

Managing your ENA – the JURA Cockpit

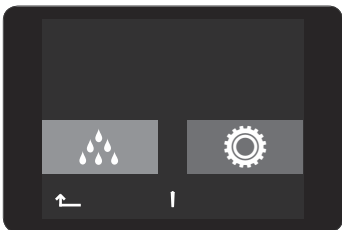
The **JURA Cockpit** allows you to manage your ENA. Tap  on the start screen to open the JURA Cockpit.



Symbol	Meaning
	'Maintenance' section
	'Machine setting' section
	Filter mode

4 Preparation

The indulgence worlds of your ENA 5

Choose between the various preparation options for coffee and espresso. Tap < or > to navigate through the three indulgence worlds of your ENA:

- **'Classic Hot Brew'**
 - The espressi and coffees are prepared using the classic hot brewing process.
- **'Cold Brew'**
 - The product is prepared using the Cold Extraction Process, which involves extraction with cold water pulsed at high pressure.
- **'Light Brew'**
 - The product is prepared using less ground coffee and at a reduced brewing temperature, making it easier to digest and ready to drink immediately.

Basic preparation procedure

Aim	Procedure
Display more products	Tap < or > to prepare the coffee or espresso in a different indulgence world
Change coffee strength	During the grinding operation, tap < or >
Change quantity	During the brewing operation, tap < or >
Stop preparation	Tap 'Cancel'
Permanently change quantity and coffee strength	Tap and hold a product for approx. 2 seconds and change the settings under 'Product settings' (temperature can also be changed for classic coffee and espresso)
Replace a product on the start screen	Tap and hold a product for around 2 seconds and reposition it under 'Reposition the product'

Espresso and coffee

Example: Coffee (**'Classic Hot Brew'**)

- Place a cup under the coffee spout.

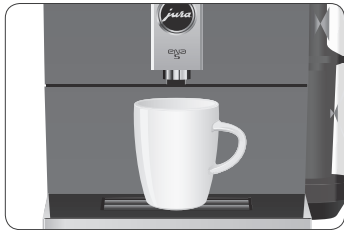

- i** For the best-tasting coffee: Pre-heat the cup. A cup warmer from JURA is available to purchase from your specialised dealer.
- Tap **'Coffee'** (page ●○○○○○).
The preset amount of water for coffee flows into the cup.

Cold Brew

Example: Cold Brew coffee

- Fill the water tank with **cold** water.

- i** The temperature of the water in the water tank affects the brewing result. Use fresh, cold water.
- Add ice cubes to a glass according to your own preferences.
- Place the glass under the coffee spout.



- ▶ Tap the > button several times to display the **third page** of the start screen (○●○○○○).

i You are now in the Cold Brew indulgence world; the screen is blue and the ☼ symbol is displayed at the top right.

- ▶ Tap 'Coffee'.
The preset amount of water for the coffee flows into the glass.

Ground coffee

You can choose to use a second coffee variety, for example decaffeinated coffee, with the filter funnel for ground coffee.

Basic information about preparing drinks:

- Activate **Ground coffee mode** in the machine settings to prepare speciality coffees using ground coffee.
- Never add more than one level measuring spoon of ground coffee.
- Use ground coffee which is not ground too finely. Very fine coffee can block up the system so that the coffee only comes out in drips.
- If you did not fill the machine with a sufficient amount of ground coffee, 'Not enough ground coffee' is displayed and the ENA stops the operation.
- The desired speciality coffee must be prepared within approximately one minute after filling with the ground coffee. Otherwise the ENA stops the operation and is once more ready for use.
- All speciality coffees with ground coffee are always prepared following the same model.

Example: Proceed as follows to prepare one espresso using ground coffee.

- ▶ Place an espresso cup under the coffee spout.
- ▶ Tap ☼ on the start screen to open the JURA Cockpit.
- ▶ Touch the 'Machine setting' ⚙ symbol.
- ▶ Tap 'Ground coffee mode'.
- ▶ Tap 'Active'.
- ▶ Touch 'Save'.

'Saved' appears briefly on the display.

i Ground coffee mode remains active until it is deactivated in the machine settings or the ENA is switched off.

- ▶ Tap 'Espresso' (page ○●○○○○).
'Please add ground coffee' / 'Close filler funnel for ground coffee'
- ▶ Open the powder chute for ground coffee.



- ▶ Fit the filler funnel for ground coffee.

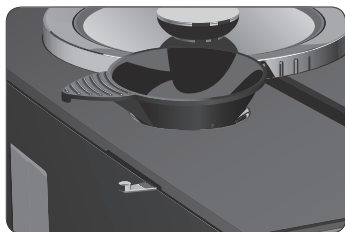

- ▶ Place one level measuring spoon of ground coffee into the filler funnel.
- ▶ Remove the filler funnel and close the cover of the powder chute.
- ▶ Touch 'Next'.
The preset amount of water for espresso flows into the cup.

Adjusting the grinder

You can adjust the grinder to suit the degree of roast of your coffee.

CAUTION

If you adjust the consistency of grind when the grinder is not operating, the grinding wheel could be damaged.

- ▶ Only adjust the consistency of grind when the grinder is running.

5 Daily operation

i The consistency of grind is correct if the coffee flows regularly from the coffee spout. In addition a fine, thick crema forms.

Grinding wheel

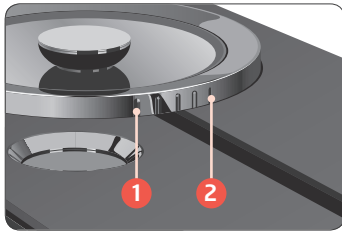

- 1: Consistency of grind setting **mild**
- 2: Consistency of grind setting **intense**

Example: Proceed as follows to change the consistency of grind **during** the preparation of an espresso.

- Place a cup under the coffee spout.
- Tap 'Espresso'.
- Turn the grinder adjustment wheel to the desired position **while** the grinder is running.

Adjusting the product settings

Touch a product on the start screen for **approximately 2 seconds** to access the settings ('Product settings').

Example: Proceed as follows to change the coffee strength for one coffee.

- Touch 'Coffee' for **approximately 2 seconds**.
- Tap 'Product settings'.
- Tap < or > to change the coffee strength setting.

i Tap the dots ● ○ ○ at the top right to access additional possible settings.

- Touch 'Save'.
- Tap **⏪** to return to the start screen.

5 Daily operation

Switching the machine on and off

- Place a receptacle under the coffee spout.



- Press the On/Off button **⏻**.

'Machine is rinsing'

Your ENA is switched on or off.

i When the machine is switched off, the system is only rinsed if a speciality coffee has been prepared.

Filling the water tank

Daily maintenance of the machine and hygiene when handling coffee and water are key to a perfect coffee result in the cup every time. You should therefore change the water **daily**.

CAUTION

Milk, sparkling mineral water or other liquids can damage the water tank or the machine.

- Only fill the water tank with fresh, cold water.
- Remove the water tank and rinse it with cold water.
- Fill the water tank with fresh, cold water and reinsert the tank.

Maintenance actions



Optimal coffee quality depends on many factors. One important prerequisite is regular maintenance of your ENA. Carry out the following steps:

Maintenance action	Daily	If necessary	Note
Empty the drip tray and coffee grounds container and rinse with warm water (The insert for the drip tray, including the drip tray itself, and the coffee grounds container are dishwasher-safe)	▪		Always empty the coffee grounds container when the machine is switched on. This is the only way of resetting the coffee grounds counter.
Rinse the water tank	▪		
Wipe the surface of the machine with a clean, soft, damp cloth (e.g. microfibre cloth)	▪		
Clean the inside of the water tank with a brush		▪	
Clean the top and bottom of the cup grille		▪	
Thoroughly clean the drip tray and coffee grounds container		▪	

i You will find more information about the maintenance of your ENA in the 'Maintenance' area  in the programme item 'Information'.





6 Machine settings

Tap  on the start screen to open the JURA Cockpit. In the 'Machine settings' section,  the following settings may be changed:

Programme item	Explanation
Page 	
'Ground coffee mode'	Activate ground coffee mode to prepare specialities with ground coffee
'Switch off after'	Set the automatic switch-off time to save energy (switch-off after 15 minutes, 30 minutes or 1 – 9 hours after the last action on the machine)
'Choose language'	Set language
'Water hardness'	Set the hardness of the water used (1 °dH to 30 °dH) to prevent limescale building up in your machine
Page 	
'Units'	Set the unit for the amount of water (ml or oz)
'Factory setting'	Reset your ENA to factory settings (the machine then switches off)
'Product name'	Display product images with/without product names on the start screen
'Empty system'	Empty the system to protect the ENA from frost damage during transport (see chapter 10 'Transport and environmentally friendly disposal – Transport / Emptying the system')
Page 	
'Version'	View software version
'Connections' (only displayed if JURA Wi-Fi Connect is being used)	Wirelessly connect the ENA to the JURA app (J.O.E.®) or disconnect again

7 Maintenance

Basics on maintenance:

- Tap  to open the Cockpit. This comprises a 'Maintenance status' section  and a 'Machine settings' section . The maintenance of your ENA is managed in the section .
- The Cockpit shows maintenance programmes that need to be carried out in the form of messages with red backgrounds. Tap a message to go straight to the corresponding maintenance programme. Maintenance programmes that are due imminently are indicated on your ENA by means of a bar display within the message.
- Carry out each maintenance programme when you are prompted to do so.



Rinsing the machine

You can start coffee system rinsing manually at any time.

Precondition: The start screen is displayed.

- Place a receptacle under the coffee spout.



- Tap  on the start screen to open the JURA Cockpit.
- Touch the 'Maintenance' symbol .
- Tap 'Rinse the coffee system' to start the rinse operation.
'Machine is rinsing'
The rinse stops automatically. The start screen is displayed.

Inserting/changing the filter

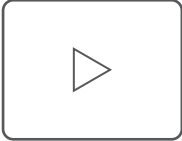

Tap, click or scan to watch
the video tutorial on YouTube



Your ENA no longer has to be descaled if you are using the CLARIS Smart+ filter cartridge.

- i** Once the filter cartridge stops working (depending on the water hardness setting), the ENA will prompt you to change the filter.
- i** CLARIS Smart+ filter cartridges are available from specialised dealers.

Precondition: The start screen is displayed. (Alternatively, the filter symbol  is displayed in red in the cockpit if the filter's capacity has been exhausted.)

- Remove and empty the water tank.
- Remove the used filter cartridge from the water tank.

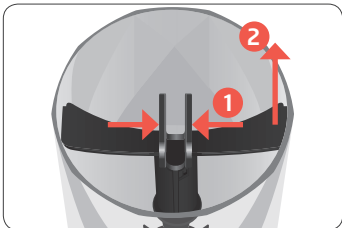

- Fit the filter cartridge extension on top of a **new** CLARIS Smart+ filter cartridge.

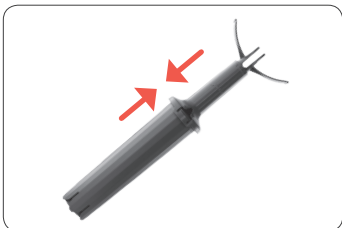

- ▶ Insert the filter cartridge with its extension into the water tank.

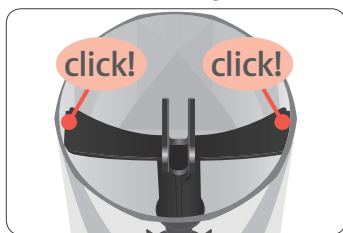

- ▶ Fill the water tank with fresh, cold water and reinsert the tank.
The machine automatically detects that you have just inserted/changed the filter cartridge.
'Filter is being rinsed', the filter is rinsed. Water flows directly into the drip tray.
The start screen is displayed.

Cleaning the machine

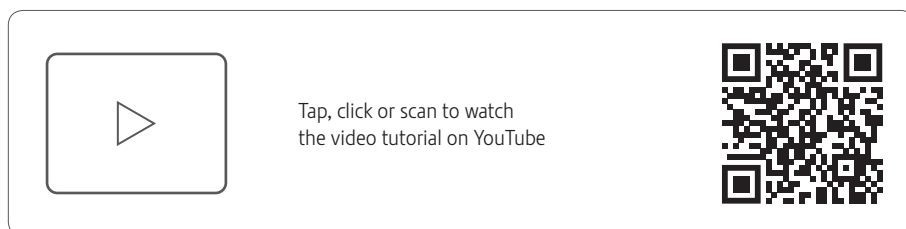

After 160 preparations or 80 switch-on rinses, the ENA will prompt you to clean it.

CAUTION

If the wrong cleaning agent is used, the machine could be damaged and/or traces could be left behind in the water.

- ▶ Use only original JURA maintenance products.

- i** The cleaning programme lasts approximately 20 minutes.
- i** Do not interrupt the cleaning programme. The quality of cleaning will be impaired if you do so.
- i** JURA cleaning tablets are available from specialised dealers.

Precondition: 'Clean' is displayed in the Cockpit.

- ▶ Fill the water tank.
- ▶ Tap 'Clean'.
- ▶ Touch 'Start'.
- ▶ 'Empty Grounds'
- ▶ Empty the drip tray and coffee grounds container and put them back into the machine.
- ▶ Place a receptacle under the coffee spout.



- ▶ Touch 'Next'.
- ▶ 'Machine is being cleaned', water flows out of the coffee spout.
The operation is interrupted, 'Add cleaning tablet'.
- ▶ Open the powder chute for ground coffee.



7 Maintenance

- ▶ Insert a JURA cleaning tablet into the powder chute.

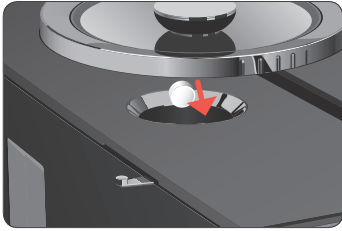

- ▶ Close the powder chute.
- ▶ Touch **'Next'**.
'Machine is being cleaned', water flows out of the coffee spout several times.
'Empty Grounds'
- ▶ Empty the drip tray and coffee grounds container and put them back into the machine.

Descaling the machine

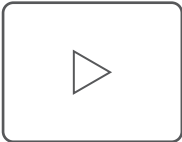

Tap, click or scan to watch
the video tutorial on YouTube



The ENA builds up deposits of limescale over time and automatically prompts you to descale it when necessary. The degree of calcification depends on the hardness of your water.

- i** If you are using a CLARIS Smart+ filter cartridge, you will not be prompted to descale.

⚠ CAUTION

If the descaling agent comes into contact with the skin or eyes, this can cause irritation.

- ▶ Avoid contact with the skin or eyes.
- ▶ Rinse off the descaling agent with clean water. Should you get any descaling agent in your eye, see a doctor.

CAUTION

If the wrong descaling agent is used, the machine could be damaged and/or traces could be left behind in the water.

- ▶ Use only original JURA maintenance products.

CAUTION

If the descaling operation is interrupted, there may be damage to the machine.

- ▶ Allow the descaling programme to run to the end.

CAUTION

If the descaling agent comes into contact with sensitive surfaces (e.g. marble), damage cannot be ruled out.

- ▶ Clean up any splashes immediately.

-
- i** The descaling programme lasts approximately 20 minutes.
 - i** JURA descaling tablets are available from specialised dealers.

Precondition: **'Descale'** is displayed in the Cockpit.

- ▶ Tap **'Descale'**.
- ▶ Touch **'Start'**.
'Empty drip tray'
- ▶ Empty the drip tray and coffee grounds container and put them back into the machine.
'Agent in tank'
- ▶ Remove and empty the water tank.

- ▶ Completely dissolve 3 JURA descaling tablets in a receptacle holding 500 ml of water. This may take several minutes.

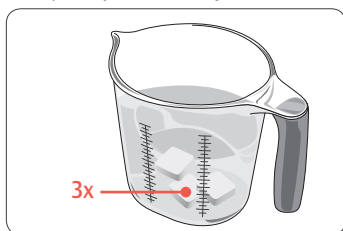

- ▶ Pour the solution into the **empty** water tank and insert it into the machine.
- ▶ Touch **'Next'**.
'Machine is being descaled', water flows repeatedly straight into the drip tray.
'Empty drip tray'.
- ▶ Empty the drip tray and coffee grounds container and put them back into the machine.
'Rinse the water tank' / 'Fill water tank'
- ▶ Remove the water tank and rinse it thoroughly.
- ▶ Fill the water tank with fresh, cold water and reinsert the tank.
- ▶ Place a receptacle under the coffee spout.



- ▶ Touch **'Next'**.
Water flows straight into the drip tray and out of the coffee spout repeatedly.
'Empty drip tray'
- ▶ Empty the drip tray and coffee grounds container and put them back into the machine.

i If the descaling operation stops unexpectedly, rinse the water tank thoroughly.

Descaling the water tank

Limescale deposits may form in the water tank. To ensure correct function of the machine, descale the water tank from time to time.

- ▶ Remove the water tank.
- ▶ If you use a CLARIS Smart+ filter cartridge, remove this.
- ▶ Completely fill the water tank and dissolve 3 JURA descaling tablets in it.
- ▶ Leave the water tank with the descaling solution for several hours (e.g. overnight).
- ▶ Empty the water tank and rinse it thoroughly.
- ▶ If you use a CLARIS Smart+ filter cartridge, insert this again.
- ▶ Fill the water tank with fresh, cold water and reinsert the tank.

Cleaning the bean container

Coffee beans may be covered with a slight oil film which remains on the walls of the bean container. These traces may negatively affect the coffee result. For this reason clean the bean container from time to time.

Precondition: 'Fill bean container' is displayed.

- ▶ Switch the machine off with the On/Off button .
- ▶ Remove the aroma preservation cover.
- ▶ Clean the bean container with a soft, dry cloth.
- ▶ Fill the bean container with coffee beans and close the aroma preservation cover.

8 Display messages

Messages on the start screen

Message	Cause/Result	Action
'Fill water tank'	The water tank is empty. You cannot prepare any products.	▶ Fill the water tank (see chapter 5 'Daily operation – Filling the water tank').
'Empty Grounds' / 'Empty drip tray'	The coffee grounds container is full. / The drip tray is full. You cannot prepare any products.	▶ Empty the coffee grounds container and the drip tray (see chapter 5 'Daily operation – Maintenance actions').
'Drip tray not fitted'	The drip tray is not inserted correctly or is not inserted at all. You cannot prepare any products.	▶ Fit the drip tray.
'Fill bean container'	The bean container is empty. You cannot prepare any products.	▶ Fill the bean container (see chapter 3 'Preparing and using for the first time – Filling the bean container').
'Not enough ground coffee'	There is insufficient ground coffee in the machine; the ENA stops the operation.	▶ The next time you prepare a beverage, add more ground coffee (see chapter 4 'Preparation – Ground coffee').

Messages in the Cockpit

Message	Cause/Result	Action
The filter symbol  lights up red. 'Filter'	The filter cartridge is used up.	▶ Replace the CLARIS Smart+ filter cartridge immediately (see chapter 7 'Maintenance – Inserting/changing the filter').
'Clean'	The ENA is prompting you to clean it.	▶ Perform cleaning (see chapter 7 'Maintenance – Rinsing the machine').
'Descale'	The ENA is prompting you to descale it.	▶ Perform descaling (see chapter 7 'Maintenance – Descaling the machine').

9 Troubleshooting

Problem	Cause/Result	Action
Coffee only comes out in drips when it is being prepared.	The coffee is ground too finely and obstructs the system.	▶ Put the grinder on a coarser setting or use coarser ground coffee.
	The water hardness may not have been correctly set.	▶ Perform descaling (see chapter 7 'Maintenance – Cleaning the machine').
There is dry ground coffee behind the coffee grounds container.	The beans used are resulting in an above-average volume of ground coffee.	▶ Reduce the coffee strength or choose a finer grinder setting (see chapter 4 'Preparation – Adjusting the product settings').
'Fill water tank' is not displayed although the water tank is empty.	There is a lot of limescale in the water tank.	▶ Descale the water tank (see chapter 7 'Maintenance – Descaling the water tank').
Grinder is making a very loud noise.	There are foreign objects in the grinder.	▶ Contact customer support in your country (see chapter '13 JURA contact details / Legal information').
'Error 2' or 'Error 5' is displayed.	If the machine has been exposed to the cold for a long period of time, heating may be disabled for safety reasons.	▶ Warm the machine at room temperature.
Other 'Error' messages will be shown.	–	▶ Switch the ENA off with the On/Off button  . Contact customer support in your country (see chapter '13 JURA contact details / Legal information').

i If you were unable to solve the problem, contact customer support in your country (see chapter '13 JURA contact details / Legal information').

10 Transport and environmentally friendly disposal

Transport / Emptying the system



Keep the packaging for your ENA. It should be used to protect the machine during transport.

In order to protect the ENA from frost during transport, the system must be emptied.

Precondition: The start screen is displayed.

- Place a receptacle under the coffee spout.



- Touch .
- Touch the 'Machine setting'  symbol.
- Switch to the  page.
- Tap 'Empty system'.
- Remove and empty the water tank.
The system is emptied.
Your ENA is switched off.



Disposal

Please dispose of old machines in an environmentally neutral way.



Old machines contain valuable, recyclable materials which should be recycled. Please therefore dispose of old machines via suitable collection systems.

11 Technical data

Voltage	220–240 V ~, 50 Hz
Power	1,450 W
Conformity mark	 
Pump pressure	Static, max. 15 bar
Holding capacity of water tank (without filter)	1.1 l
Holding capacity of bean container	125 g
Holding capacity of coffee grounds container	approx. 10 servings
Cable length	approx. 1.2 m
Weight	approx. 8.7 kg
Dimensions (W × H × D)	27.1 × 32.3 × 44.5 cm
CLARIS filter cartridge Smart+ (RFID technology)	Frequency band 13.56 MHz Max. transmission power < 1 mW
JURA Wi-Fi Connect (Wi-Fi connection)	Frequency band 2.4 GHz Max. transmission power < 100 mW

12 Index

A

- Addresses 19
- Adjusting the product settings 10
- Aroma preservation cover
 - Bean container with aroma preservation cover 3

B

- Bean container
 - Bean container with aroma preservation cover 3
 - Cleaning 15
 - Filling 6
- Bus bar
 - Technical data 17
- Button
 - On/Off button 3

C

- Children 4
- CLARIS Smart filter cartridge
 - Changing 12
 - Inserting 12
- Cleaning
 - Bean container 15
 - Machine 13
- Cockpit 7, 11
- Coffee 8
- Coffee grounds container 3
- Coffee spout
 - Height-adjustable coffee spout 3
- Cold Brew 8
- Consistency of grind
 - Adjusting the grinder 9
 - Grinding wheel 3, 10
- Contact details 19
- Cup grille 3
- Customer support 19

D

- Damage
 - Preventing damage 5
 - What to do in the event of damage 4
- Declaration of Conformity 19
- Descaling
 - Machine 14
 - Water tank 15
- Display
 - Cockpit 7
 - Touch display 3
- Display messages 16
- Disposal 17
- Drip tray 3
 - Insert 3

E

- Emptying the system 17
- Errors
 - Troubleshooting 16
- Espresso 8
- EU Declaration of Conformity 19

F

- Filler funnel
 - Filler funnel for ground coffee 3
- Filling
 - Bean container 6
 - Water tank 10
- Filter
 - Changing 12
 - Inserting 12
- First-time use 6

G

- Ground coffee 9
 - Measuring spoon for ground coffee 3
 - Powder chute for ground coffee 3

H

- Height-adjustable coffee spout 3
- Hotline 19

I

- Insert for drip tray 3
- Instant coffee
 - Ground coffee 9

J

- JURA
 - Contact details 19

M

- Machine
 - Cleaning 13
 - Descaling 14
 - Rinsing 12
 - Setting up 6
- Machine settings 11
- Mains cable 3
- Maintenance 11
- Maintenance actions 11
- Measuring spoon for ground coffee 3
- Messages, display 16

P

- Powder chute
 - Powder chute for ground coffee 3
- Preparation 8
 - Coffee 8
 - Cold Brew 8
 - Espresso 8
 - Ground coffee 9
- Problems
 - Troubleshooting 16
- Product settings
 - Adjusting 10
- Proper use 4

R

- RFID 17
- Rinsing
 - Machine 12

S

- Safety information 4
- Service socket 3
- Setting up
 - Setting up the machine 6
- Switching off 10
- Switching on 10
- Symbol description 4

T

- Technical data 17
- Tel 19
- Touch display 3
- Transport 17
- Troubleshooting 16

U

- Use, First-time 6
- Users 4

W

- Water hardness
 - Determining the water hardness 6
- Water tank 3
 - Descaling 15
 - Filling 10
- Wi-Fi 17
- Wi-Fi Connect 3
- Wireless connection 12, 17

13 JURA contact details / Legal information

JURA Elektroapparate AG
 Kaffeeweltstrasse 10
 CH-4626 Niederbuchsiten
 Tel. +41 (0)62 38 98 233

- i** You can find additional contact details for your country at jura.com.
- i** If you need assistance with using your machine, you can find this at jura.com/service.
- i** Your opinion is important to us! Use the contact details at jura.com.

Directives

The machine complies with the following directives:

- 2014/35/EU – Low Voltage Directive
- 2014/30/EU – Electromagnetic Compatibility
- 2009/125/EC – Ecodesign Directive
- 2011/65/EU – RoHS Directive
- 2014/53/EU – Wireless Voltage Directive

A detailed EU Declaration of Conformity for your ENA can be found at jura.com/conformity.

Technical changes

We reserve the right to make technical changes. The diagrams used in these instructions for use are for illustration purposes only and do not represent the original colours of the machine. Some details of your ENA may vary.