

## J.O.E.® Onboarding

Check smartphone and J.O.E.® app version:

- Is the latest app version installed?
- Android-Version 8.0 (or higher)
- iOS-Version 14.0 (or higher)

Check permissions:

- Are Location Services for the app J.O.E.® turned ON?
- Are all permissions given to J.O.E.®?
- Is the WLAN allowing everything?
- Is your Bluetooth ON?

Check WLAN settings:

- Router frequency set to 2.4 GHz (not 5 GHz)
- Channels 1 to 11 (not higher)
- Disable the 20/40 MHz Coexistence
- The Wi-Fi password must be known

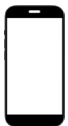

- ▶ Connect your smartphone to the WLAN and switch on Bluetooth.
- ▶ Open the location settings.
- ▶ Always allow location access for the J.O.E.® app.

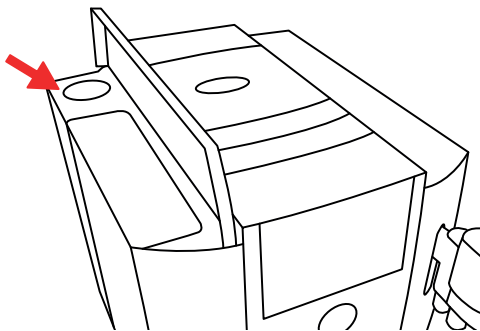

- ▶ Open the Water tank cover.
- ▶ Plug the Wi-Fi Connect into the coffee machine's service socket.  
(Some models already have it plugged in)
- ▶ Switch on the coffee machine.

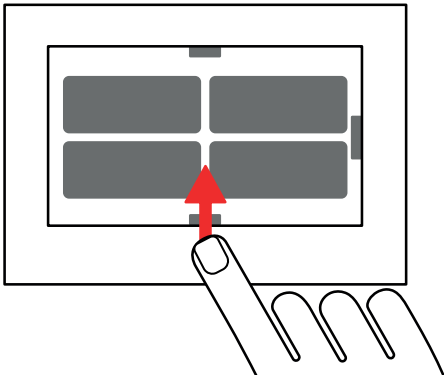

▶ Swipe your finger across the start screen from bottom to top.

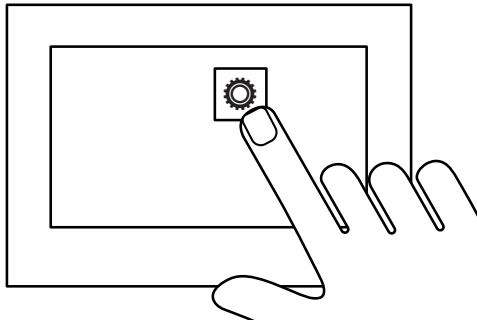

▶ Touch the 'Machine setting'  symbol.

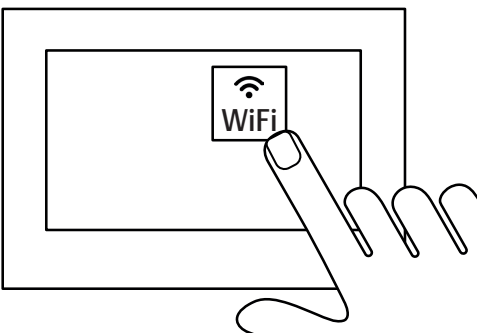

▶ Touch 'WiFi connection'.

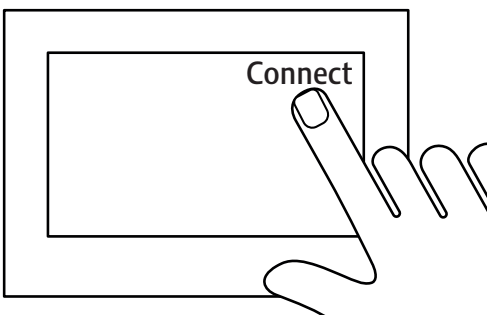

▶ Touch 'Connect'.

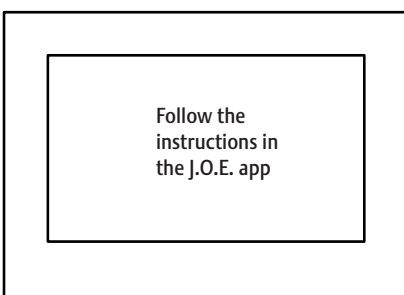

▶ Continue with the next step of these instructions.

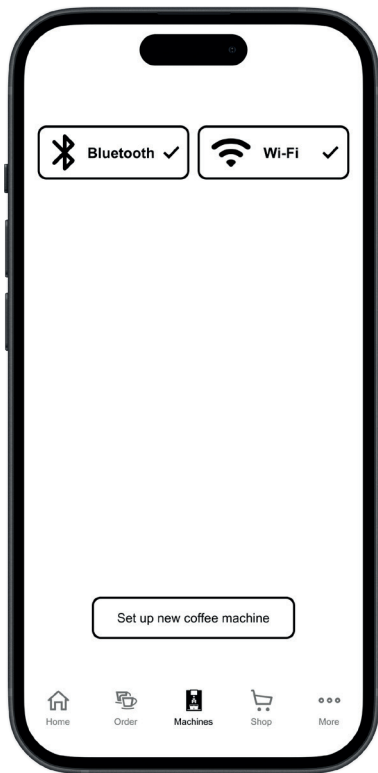

- ▶ Open the J.O.E.® app on your device.
- ▶ Touch 'Machines'.
- ▶ Touch 'Set up new coffee machine'.



- ▶ Check whether Bluetooth and Wi-Fi are active (outlined green).
- ▶ If not, connect your device to your WLAN and switch on Bluetooth.
- ▶ Touch 'Next'

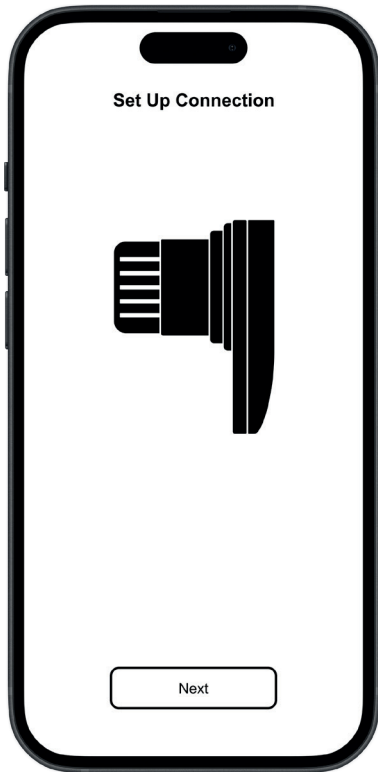

- ▶ If you have already plugged in the Wi-Fi Connect, you can touch 'Next'. Otherwise, first plug in the Wi-Fi Connect as described on page 1.

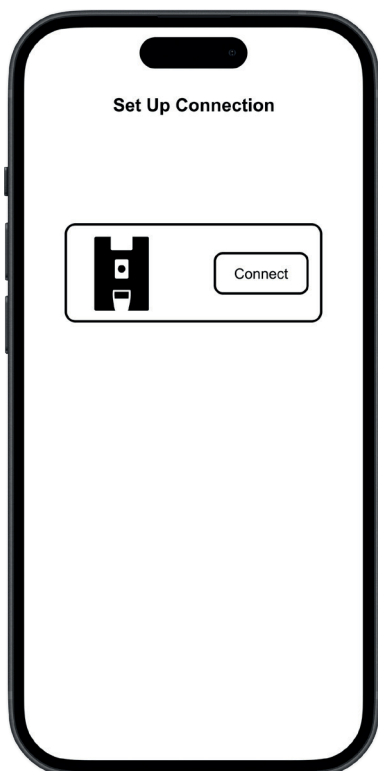

- Your coffee machine should now be displayed.
- ▶ Touch 'Connect'.

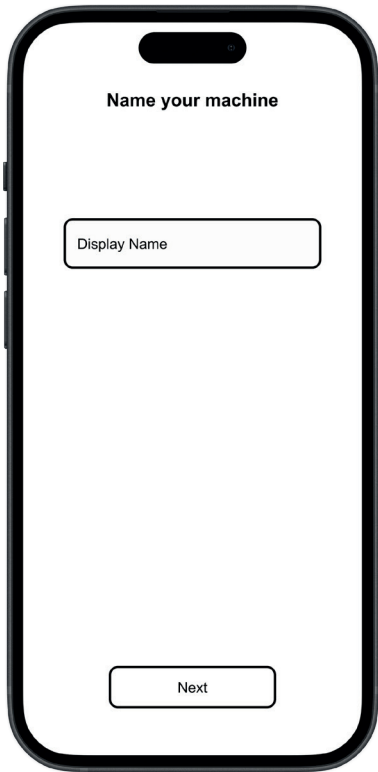

► Give your coffee machine a name and touch 'Next'.



► Enter the desired pin or skip this step.



- ▶ Enter Wi-Fi password. It must be the same as the one you used to connect your smartphone.
- ▶ Touch 'Next'.

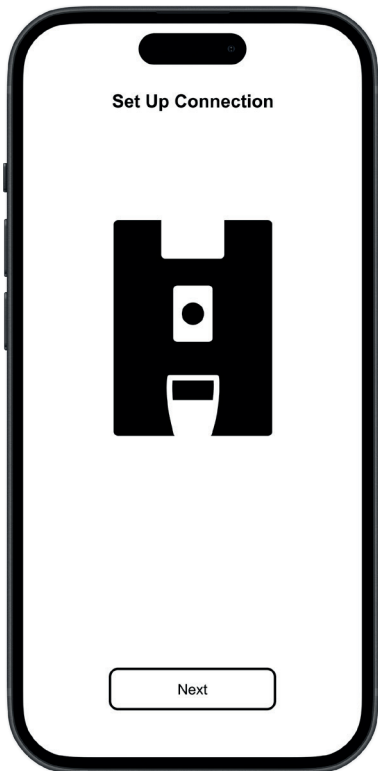

- ▶ Touch 'Next'.

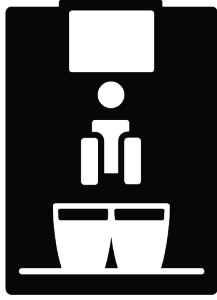

- ▶ Go back to the the start screen.  
(Some machines do this automatically)

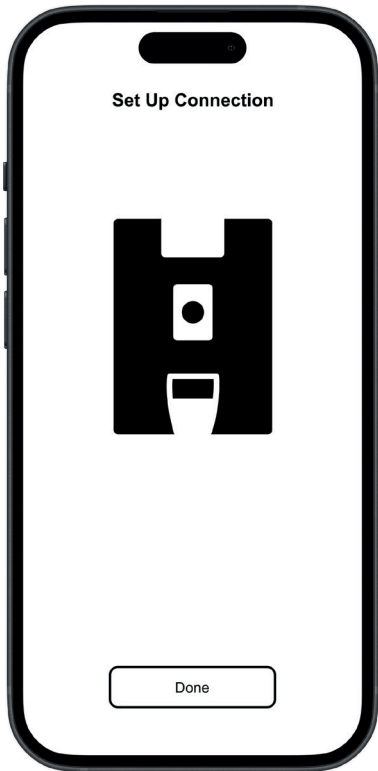

- ▶ Touch 'Done'.

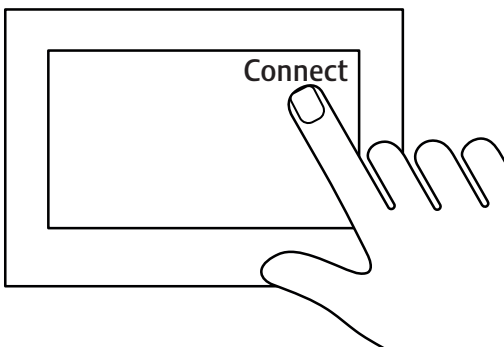

- ▶ Touch '**Connect**' to confirm the connection with J.O.E.® .  
You have 30 seconds to do this.



If you were unable to connect, check all the settings from the prerequisites and try again.  
If you still have problems with the onboarding, go to the J.O.E.® app under 'More' (bottom right)  
and call our Digital Customer Support.